

POHLED ZPRAVA
(SMĚR TOKU →)

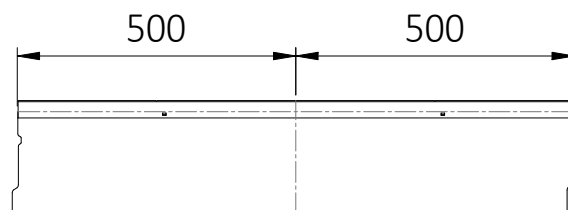

POHLED ZPŘEDU

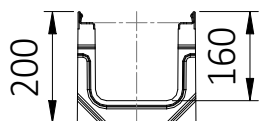

POHLED SHORA

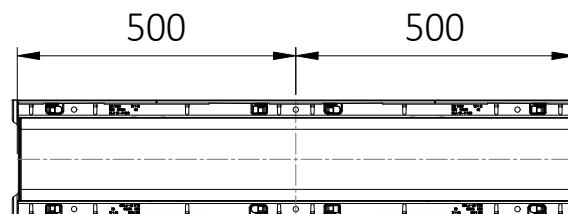

PROSTOROVÉ ZOBRAZENÍ

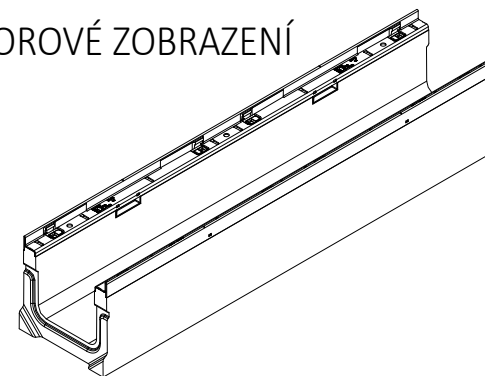

POHLED ZE ZADU

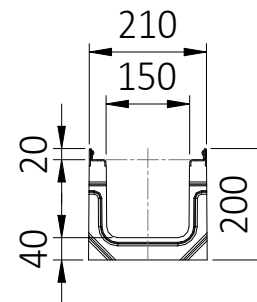

POHLED ZLEVA

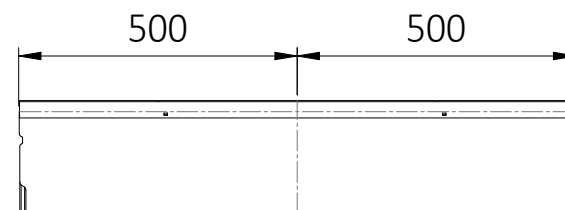

DETAIL ULOŽENÍ U
OKOLNÍHO TERÉNU

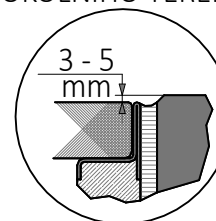

hauraton		benefit	
GSM: +420 603 429 451 email: info@benefit.cz tel: +420 553 628 776 Benefit stavební prvky s.r.o., Jarkovická 102/10, 746 01 Opava Vlašovičky			
www.hauraton.cz		www.benefit.cz	
NÁZEV PROJEKTU:	DATUM:	30-10-2020	
FASERFIX KS 150 TYP 200	VYPRACOVAL:	Petr Studený	
ŽLAB FASERBETON DO TŘ. F 900	KONTROLOVAL:	Petr Studený	
RÁM ŽÁROVĚ ZN OCEĽ	Č.NÁVRHU:	Č.VÝKRESU:	
POPIS:	01/2020	01	
SCHÉMA LINIOVÉHO ŽLABU			